

**MATERIALS**

HOUSING: THERMOPLASTIC (UL 94V-0), BLACK  
 SHELL: COPPER ALLOY, NICKEL PLATING  
 TERMINAL: COPPER ALLOY, GOLD PLATING ON CONTACT AREA  
 TIN PLATING ON SOLDER TAIL

**SPECIFICATION**

CURRENT RATING: 1 AMP MAX  
 DIELECTRIC WITHSTANDING: 500V AC FOR ONE MINUTE  
 CONTACT RESISTANCE: 30m OHMS MAX  
 INSULATION RESISTANCE: 1000M OHMS MIN AT DC 500V  
 OPERATION TEMPERATURE: -25°C~+85°C

**PART NUMBER:**

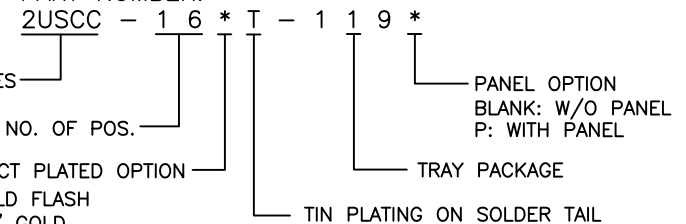

- CONTACT PLATED OPTION
- 1: GOLD FLASH
- 3: 3u" GOLD
- 5: 5u" GOLD
- 6: 10u" GOLD
- 7: 15u" GOLD
- 9: 30u" GOLD

A	RELEASE	2015.8.7
REV.	DESCRIPTION	DATE

**Cyberconn Technology Co., Ltd.**  
 www.cyberconn.com.tw Tel: +886-3-4951314

TOLERANCES	USB CONNECTOR SERIES					
X.X ±0.3	TITLE STACKED 4X1 USB A TYPE, PCB MOUNT, R/A METAL SHIELD, FEMALE					
X.XX ±0.2	DRAWN BY		CHECKED BY		APPROVED BY	
X.XXX ±0.1	Tina		Lion		Benson	
Angle ±5°	UNIT	SCALE	SIZE	DRAW NO.	REV.	Sheet
	10144	MM	NONE	A4	2USCC-009	A 1/2

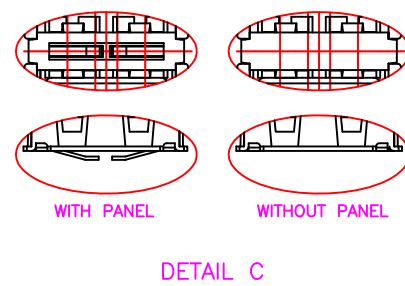
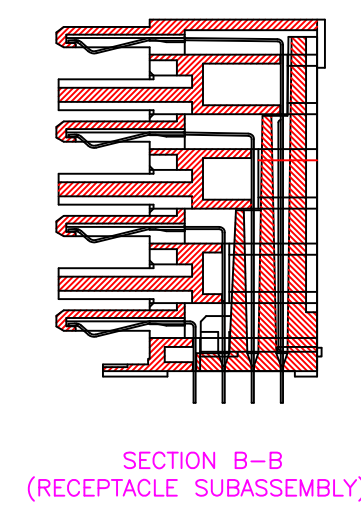
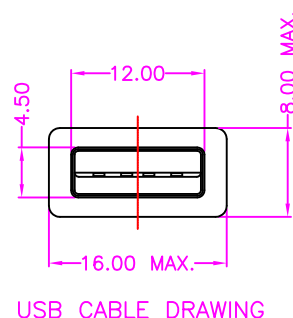
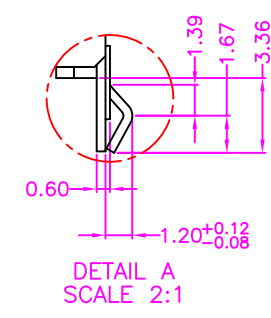
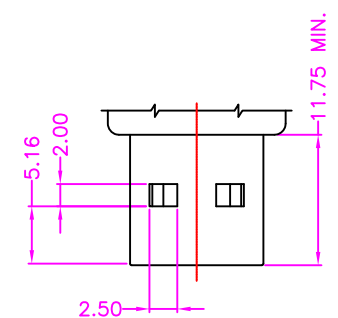
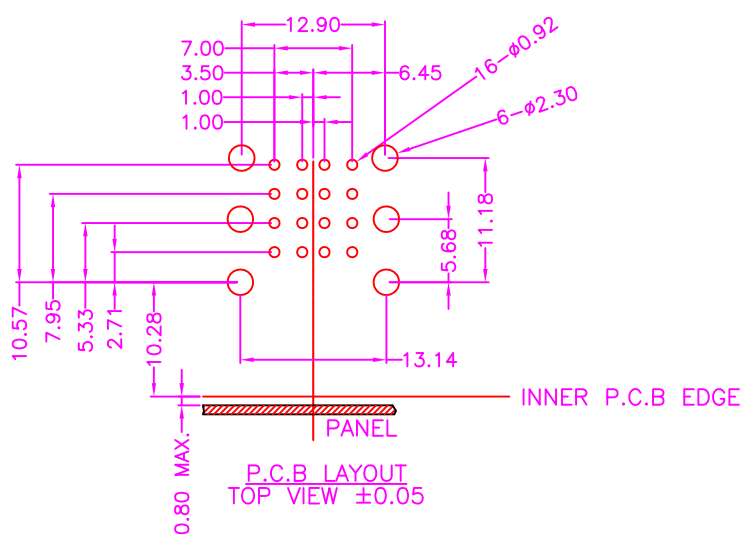

**Cyberconn Technology Co., Ltd.**  
www.cyberconn.com.tw Tel: +886-3-4951314

TOLERANCES X.X $\pm 0.3$ X.XX $\pm 0.2$ X.XXX $\pm 0.1$ Angle $\pm 5^\circ$	TITLE	USB CONNECTOR SERIES STACKED 4X1 USB A TYPE, PCB MOUNT, R/A METAL SHIELD, FEMALE				
	DRAWN BY	CHECKED BY	APPROVED BY			
	<i>Tina</i>	<i>Lion</i>	<i>Benson</i>			
	UNIT	SCALE	SIZE	DRAW NO.	REV.	Sheet
10144	MM	NONE	A4	2USCC-009	A	2/2

A	RELEASE	2015.8.7
REV.	DESCRIPTION	DATE