

MATERIALS

HOUSING: LCP (UL 94V-0), BLACK
 BOARDLOCK: COPPER ALLOY, TIN PLATING
 TERMINAL: COPPER ALLOY, GOLD PLATED ON CONTACT AREA
 TIN PLATING ON SOLDER TAIL

SPECIFICATION

CURRENT RATING: 1.5 AMP MAX
 DIELECTRIC WITHSTANDING: 500V AC FOR ONE MINUTE
 CONTACT RESISTANCE: 30m OHMS MAX
 INSULATION RESISTANCE: 1000M OHMS MIN AT DC 500V
 OPERATION TEMPERATURE: -40°C~+105°C

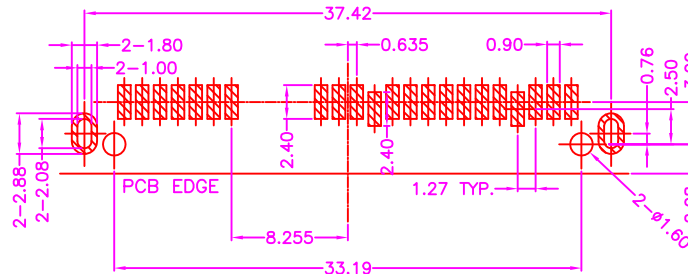
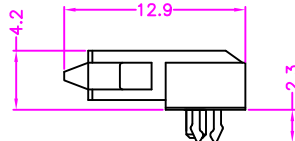
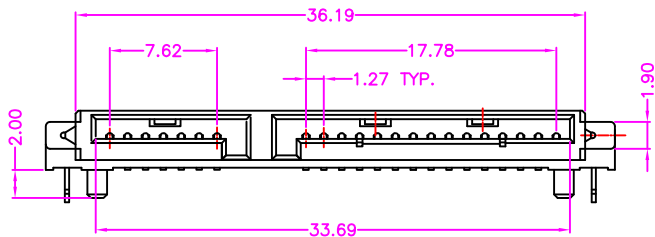

P.C.B. LAYOUT TOP VIEW ±0.05

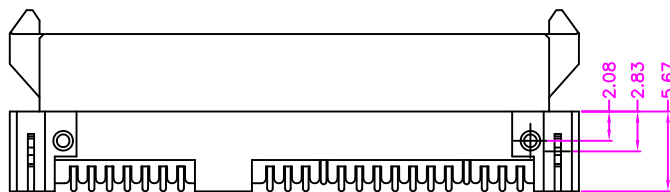

PART NUMBER:
 2SAJB - 2 2 * T - 1 1 1

SERIES — NO. OF POS. — CONTACT PLATED OPTION — TIN PLATING ON SOLDER TAIL — TRAY PACKAGE

- CONTACT PLATED OPTION
- 1: GOLD FLASH
 - 3: 3u" GOLD
 - 5: 5u" GOLD
 - 7: 15u" GOLD
 - 9: 30u" GOLD

Cyberconn Technology Co., Ltd.
 www.cyberconn.com.tw Tel:+886-3-4951314

TOLERANCES	TITLE	SATA CONNECTOR SERIES				
X.X ±0.3	SATA 7+15 PIN, PCB MOUNT, R/A SMT FEMALE WITH POST & BOARDLOCK, H=4.20mm	DRAWN BY		CHECKED BY	APPROVED BY	
X.XX ±0.2		Tina		Lion	Benson	
X.XXX ±0.1		UNIT	SCALE	SIZE	DRAW NO.	REV.
Angle ±5°	10006	MM	NONE	A4	2SAJB-001	B
					Sheet	1/2

B	MODIFY DRAW.	2015.10.29
A	RELEASE	2013.3.7
REV.	DESCRIPTION	DATE

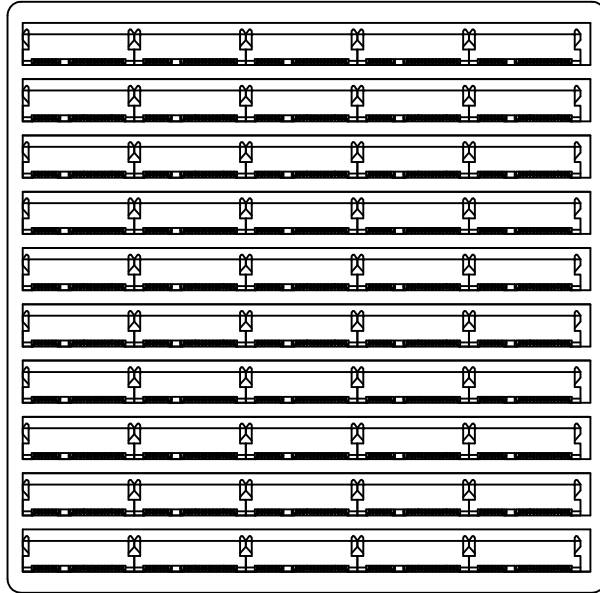
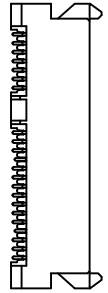

TRAY: 195X210X9mm

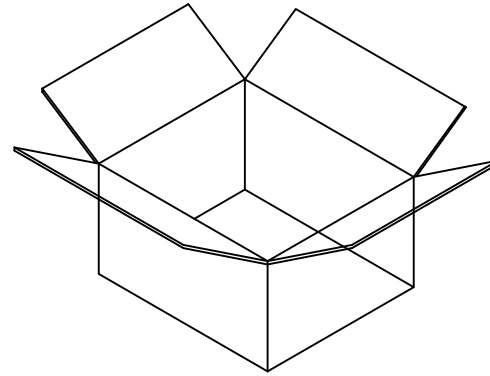

CARTON: 520X520X250mm

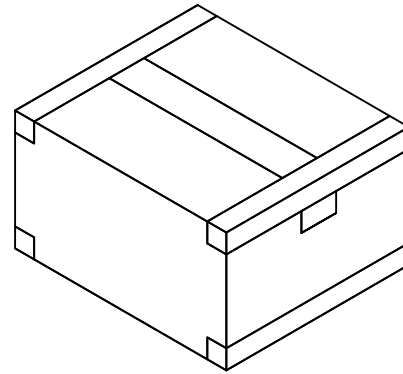

NOTE: 50PCS/ TRAY, 2500PCS/ 50 TRAY/ CARTON

B	MODIFY DRAW.	2015.10.29
A	RELEASE	2013.3.7
REV.	DESCRIPTION	DATE

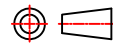
 Cyberconn Technology Co., Ltd. <small>www.cyberconn.com.tw Tel.+886-3-4951314</small>						
TOLERANCES		TITLE				
X.X ±0.3		SATA CONNECTOR SERIES				
X.XX ±0.2		SATA 7+15 PIN, PCB MOUNT, R/A SMT				
X.XXX ±0.1		FEMALE WITH POST & BOARDLOCK, H=4.20mm				
Angle ±5°		DRAWN BY		CHECKED BY		APPROVED BY
		<i>Tina</i>		<i>Lion</i>		<i>Benson</i>
UNIT	SCALE	SIZE	DRAW NO.	REV.	Sheet	
10006	MM	NONE	A4	2SAJB-001	B	2/2