

DETAIL C  
SCALE 2:1

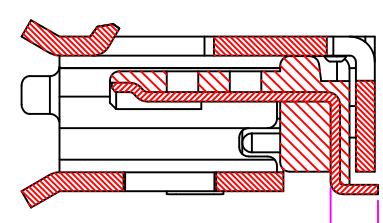

SECTION A-A  
SCALE 2:1

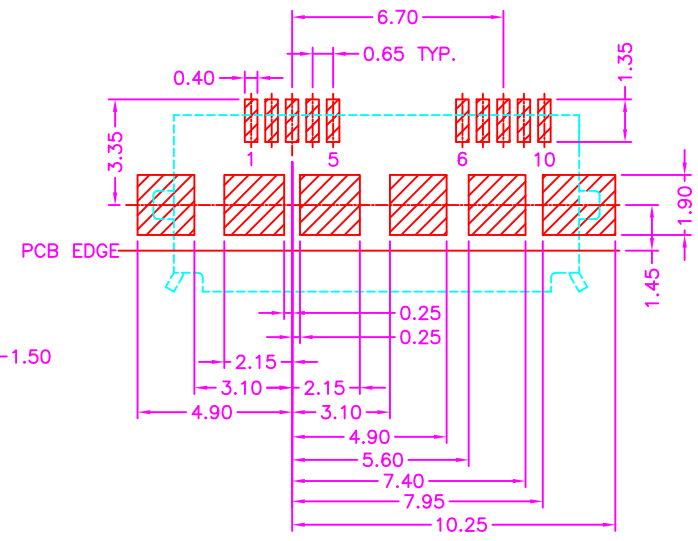

P.C.B. LAYOUT  
TOP VIEW ±0.05

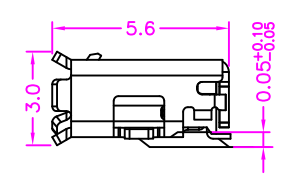
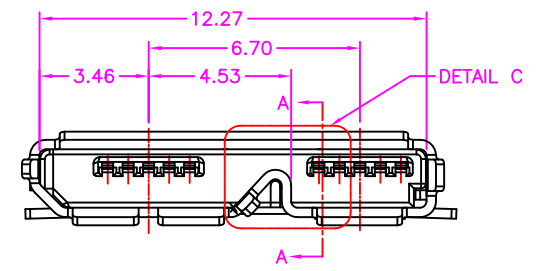

**MATERIALS**

HOUSING: HI-TEMP. PLASTIC (UL 94V-0), BLACK  
 SHELL: STAINLESS STEEL, NICKEL PLATING  
 TERMINAL: COPPER ALLOY, GOLD PLATED ON CONTACT AREA  
 TIN PLATING NO SOLDER TAIL

**SPECIFICATION**

CURRENT RATING: 0.5 AMP MAX  
 DIELECTRIC WITHSTANDING: 250V AC FOR ONE MINUTE  
 CONTACT RESISTANCE: 30m OHMS MAX  
 INSULATION RESISTANCE: 100M OHMS MIN AT DC 500V  
 OPERATION TEMPERATURE: -25°C~+80°C

Pin NO.	Signal Name
1	VBUS
2	D-
3	D+
4	ID
5	GND
6	MicB_SSTX-
7	MicB_SSTX+
8	GND_DRAIN
9	MicB_SSRX-
10	MicB_SSRX+

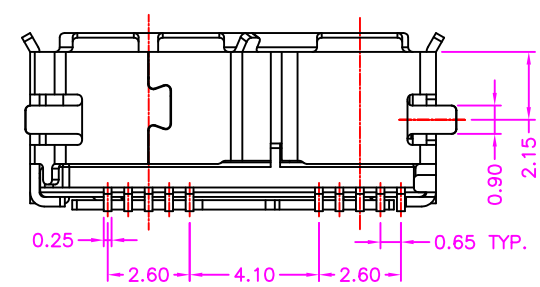

PART NUMBER:  
 2USWA - 1 0 \* T - 1 \* 4

SERIES: 2USWA  
 NO. OF POS.: 10  
 CONTACT PLATED OPTION: 1 (GOLD FLASH), 3 (3u" GOLD), 5 (5u" GOLD), 6 (10u" GOLD), 7 (15u" GOLD), 9 (30u" GOLD)  
 PACKAGE OPTION: 1 (TRAY), 2 (TAPE REEL)  
 TIN PLATING ON SOLDER TAIL

**Cyberconn Technology Co., Ltd.**  
 www.cyberconn.com.tw Tel: +886-3-4951314

TOLERANCES	USB CONNECTOR SERIES				
X.X ±0.3	TITLE: MICRO USB 3.0 B TYPE, PCB MOUNT, SMT METAL SHIELD, FEMALE				
X.XX ±0.2	DRAWN BY: Tina		CHECKED BY: Lion		APPROVED BY: Benson
X.XXX ±0.1	UNIT: MM	SCALE: NONE	SIZE: A4	DRAW NO.: 2USWA-004	REV. A
Angle ±5°	Sheet 1/2				

A	RELEASE	2015.7.13
REV.	DESCRIPTION	DATE

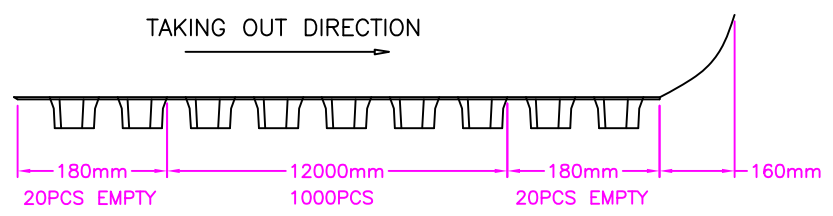
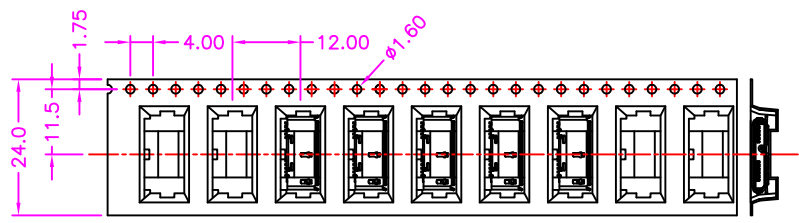
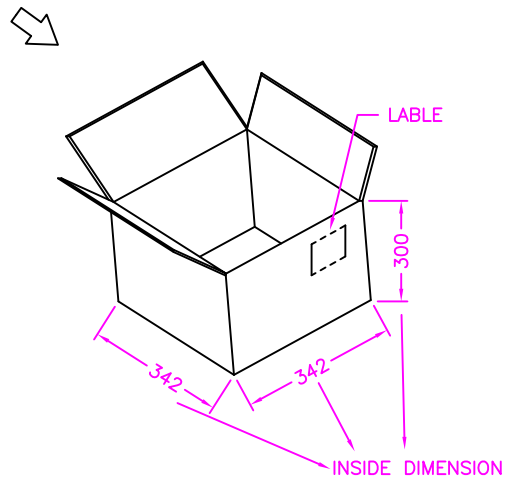
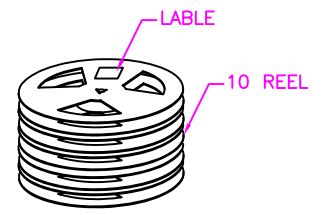
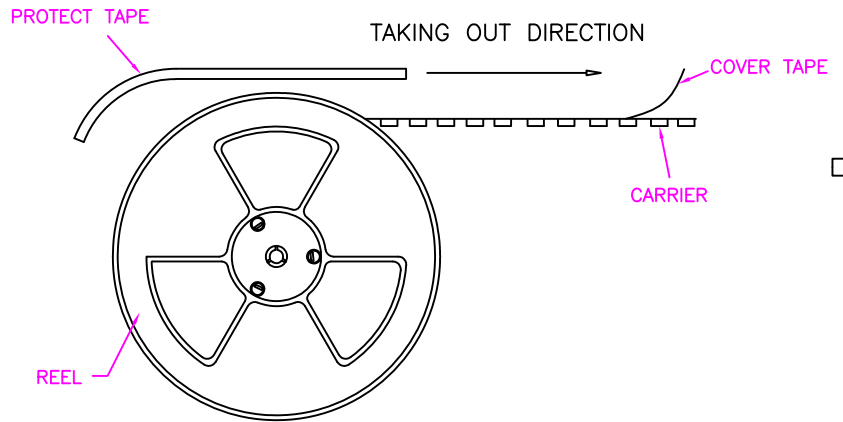

NOTE: 1000 PCS/REEL, 10 REEL/CARTON, 10000PCS/CARTON

A	RELEASE	2015.7.13
REV.	DESCRIPTION	DATE

<b>Cyberconn Technology Co., Ltd.</b> <small>www.cyberconn.com.tw Tel:+886-3-4951314</small>						
TOLERANCES		TITLE				
X.X ±0.3		USB CONNECTOR SERIES MICRO USB 3.0 B TYPE, PCB MOUNT, SMT METAL SHIELD, FEMALE				
X.XX ±0.2						
X.XXX ±0.1						
Angle ±5°						
		DRAWN BY		CHECKED BY		APPROVED BY
		<i>Tina</i>		<i>Lion</i>		<i>Benson</i>
UNIT	SCALE	SIZE	DRAW NO.	REV.	Sheet	
10152	MM	NONE	A4	2USWA-004	A	2/2