

PART NUMBER:  
026BM - 0 \* \* - 1 \* \*

SERIES

LOGO OPTION  
BLANK: W/O LOGO  
L: WITH "CTC" LOGO

LIGHT PIPES OPTION  
1: WITH INNER & OUTER LIGHT PIPES  
2: WITH OUTER LIGHT PIPES  
3: WITH INNER LIGHT PIPES

TRAY PACKAGE

SHIELD PLATING OPTION  
N: NICKEL PLATING  
C: NO PLATING (COPPER, NICKEL, ZINC ALLOY)

CONNECTOR TERMINAL PLATING OPTION  
1: GOLD FLASH  
7: 15u" GOLD

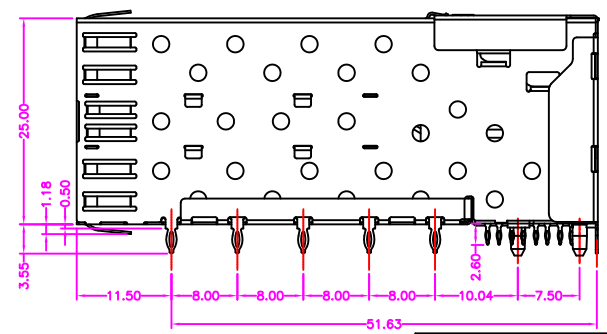
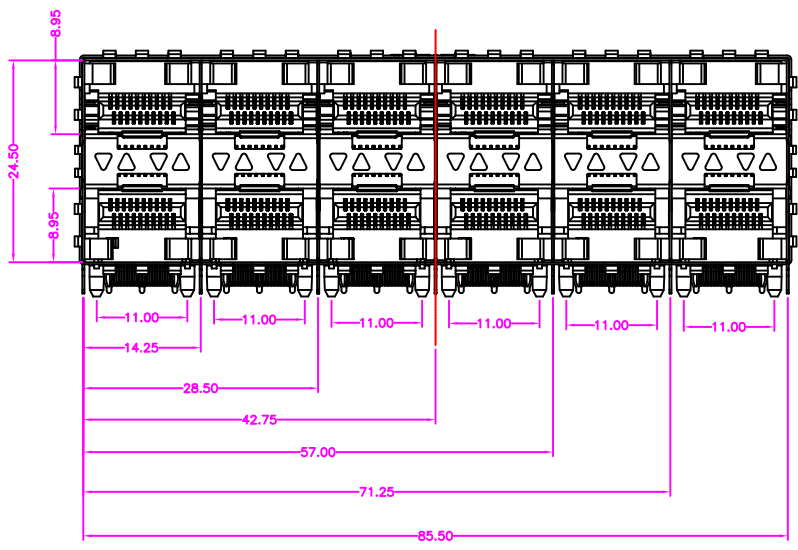

**Cyberconn Technology Co., Ltd.**  
www.cyberconn.com.tw Tel:+886-3-4951314

TOLERANCES	TITLE	SFP SERIES				
X.X ±0.20	STACKED SFP+ 2x6 CAGE, R/A, METAL SHIELD PRESS FIT TYPE WITH LIGHT PIPE & CONNECTOR	DRAWN BY		CHECKED BY		APPROVED BY
X.XX ±0.15		<i>Janice</i>		<i>Lion</i>		<i>Benson</i>
X.XXX ±0.10	UNIT	SCALE	SIZE	DRAW NO.	REV.	Sheet
Angle ±5°		10001	NONE	A4	026BM-001	A

A	RELEASE	2014.2.17
REV.	DESCRIPTION	DATE

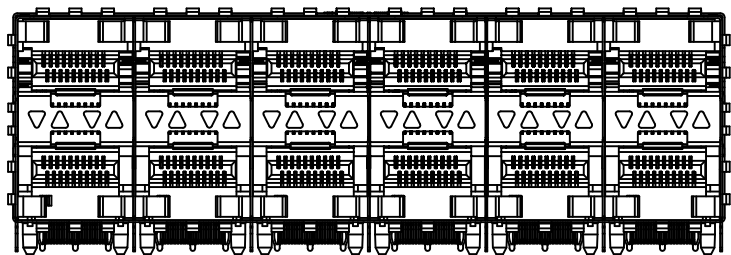

026BM-O\*\*-11\*  
WITH INNER & OUTER LIGHT PIPES

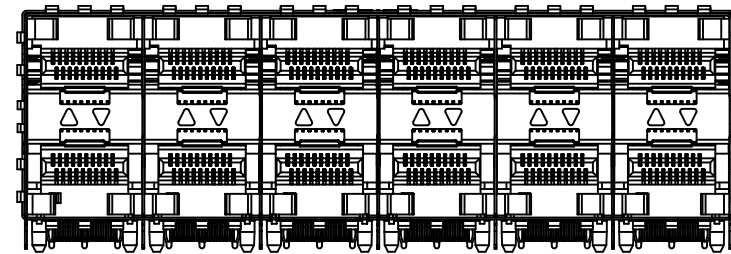

026BM-O\*\*-13\*  
WITH INNER LIGHT PIPES

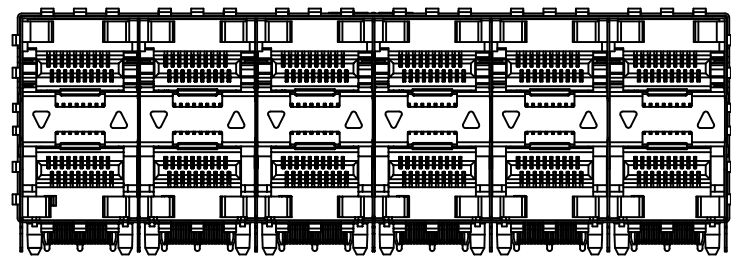

026BM-O\*\*-12\*  
WITH OUTER LIGHT PIPES

A	RELEASE	2014.2.17
REV.	DESCRIPTION	DATE

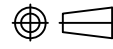
 <b>Cyberconn Technology Co., Ltd.</b> <small>www.cyberconn.com.tw Tel:+886-3-4951314</small>							
TOLERANCES		SFP SERIES					
X.X ±0.20		TITLE STACKED SFP+ 2x6 CAGE, R/A, METAL SHIELD PRESS FIT TYPE WITH LIGHT PIPE & CONNECTOR					
X.XX ±0.15							
X.XXX ±0.10		DRAWN BY	CHECKED BY	APPROVED BY			
Angle ±5°		<i>Janice</i>	<i>Lion</i>	<i>Benson</i>			
		UNIT	SCALE	SIZE	DRAW NO.	REV.	Sheet
		10001	MM	NONE	A4	026BM-001	A

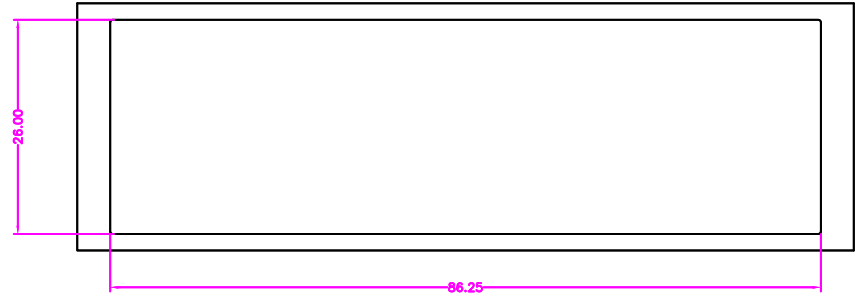

BEZEL CUT-OUT CENTER SPACING DETAIL  
BEZEL THICKNESS:0.8-2.6

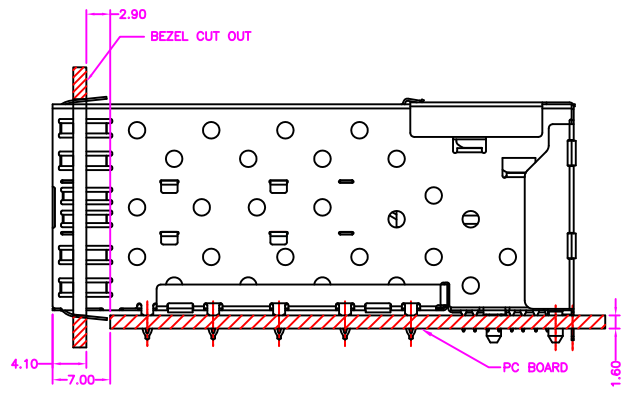

**MATERIALS**

- SFP CONNECTOR
- HOUSING: LCP (UL 94V-0), BLACK
- TERMINAL: COPPER ALLOY, GOLD PLATED ON CONTACT AREA  
TIN PLATING ON SOLDER TAIL
- SFP CAGE
- METAL SHIELD:
  - TOP: COPPER ALLOY, NICKEL PLATING
  - MIDDLE: SUS, NICKEL PLATING
  - BOTTOM: COPPER ALLOY, NICKEL PLATING
  - BACK: COPPER ALLOY, NICKEL PLATING
- BRACKET: COPPER ALLOY

LIGHT PIPE: PC

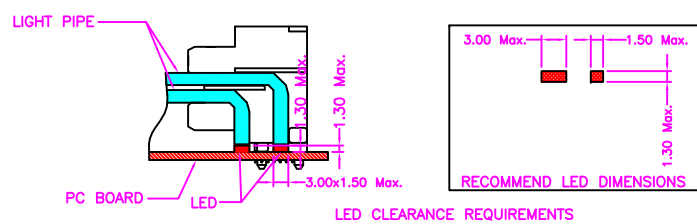

A	RELEASE	2014.2.17
REV.	DESCRIPTION	DATE

<b>Cyberconn Technology Co., Ltd.</b> www.cyberconn.com.tw Tel:+886-3-4951314						
TOLERANCES		SFP SERIES				
X.X ±0.20 X.XX ±0.15 X.XXX ±0.10 Angle ±5°		TITLE STACKED SFP+ 2x6 CAGE, R/A, METAL SHIELD PRESS FIT TYPE WITH LIGHT PIPE & CONNECTOR				
		DRAWN BY		CHECKED BY		APPROVED BY
		<i>Janice</i>		<i>Lion</i>		<i>Benson</i>
		UNIT	SCALE	SIZE	DRAW NO.	REV. Sheet
		10001	MM	NONE	A4 026BM-001	A 3/5

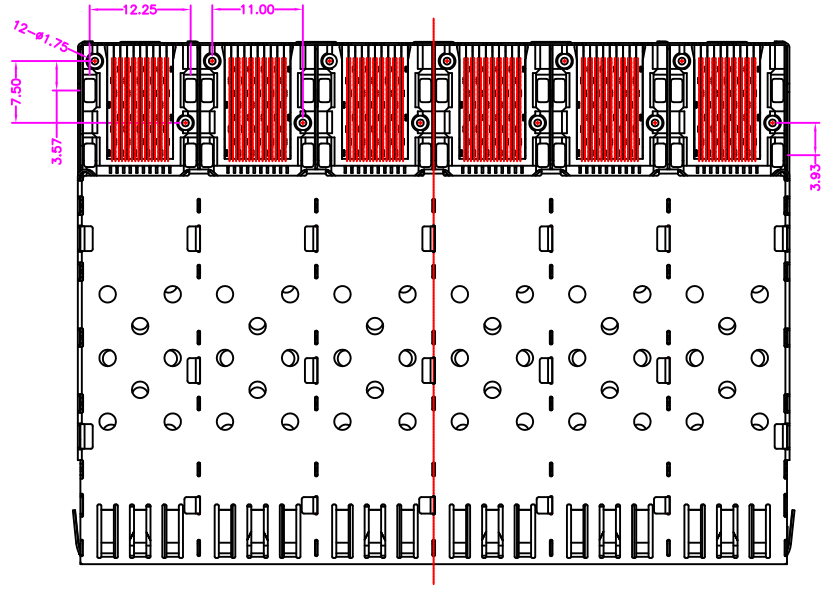
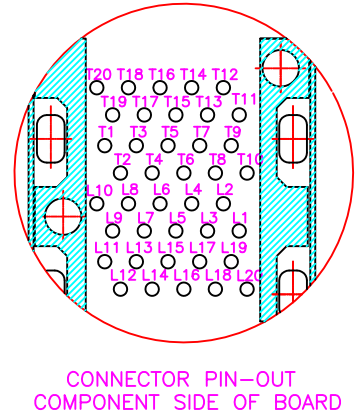
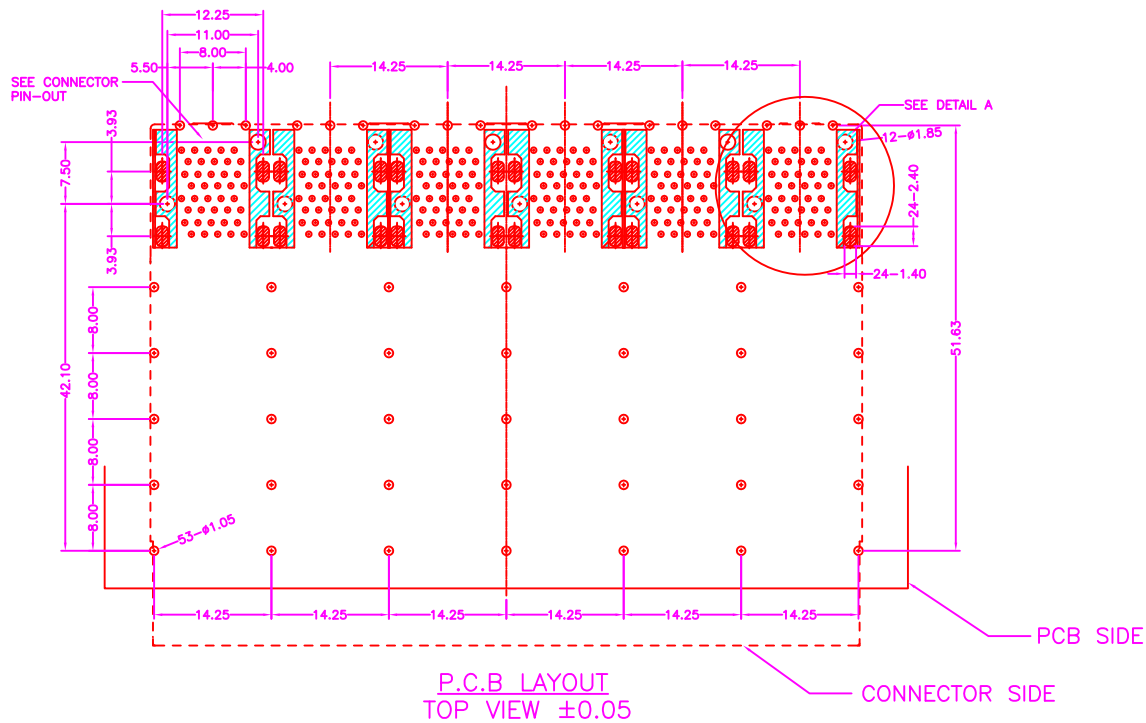

A	RELEASE	2014.2.17
REV.	DESCRIPTION	DATE

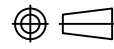
 <b>Cyberconn Technology Co., Ltd.</b> <small>www.cyberconn.com.tw Tel:+886-3-4951314</small>						
TOLERANCES		SFP SERIES				
X.X ±0.20		STACKED SFP+ 2x6 CAGE, R/A, METAL SHIELD				
X.XX ±0.15		PRESS FIT TYPE WITH LIGHT PIPE & CONNECTOR				
X.XXX ±0.10		DRAWN BY		CHECKED BY		APPROVED BY
Angle ±5°		<i>Janice</i>		<i>Lion</i>		<i>Benson</i>
		UNIT	SCALE	SIZE	DRAW NO.	REV. Sheet
10001		MM	NONE	A4	026BM-001	A 4/5

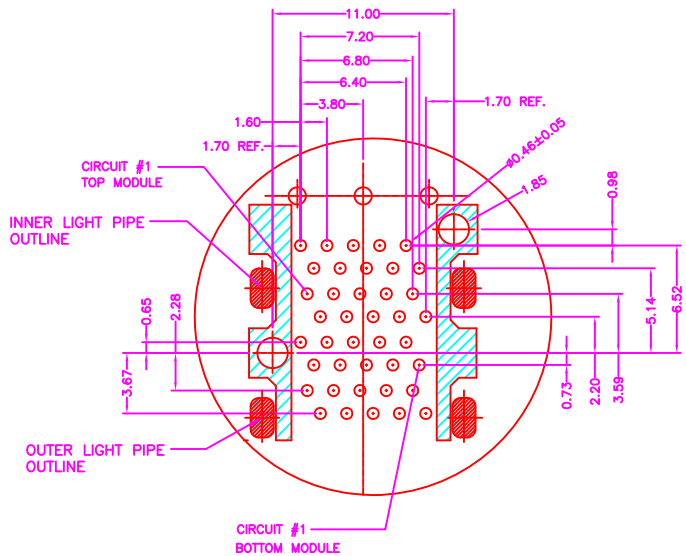

P.C.B. LAYOUT  
TOP VIEW ±0.05  
  
DEATIL A  
SCALE 2:1

A	RELEASE	2014.2.17
REV.	DESCRIPTION	DATE

<b>Cyberconn Technology Co., Ltd.</b> www.cyberconn.com.tw Tel:+886-3-4951314							
TOLERANCES		SFP SERIES					
X.X ±0.20		TITLE STACKED SFP+ 2x6 CAGE, R/A, METAL SHIELD PRESS FIT TYPE WITH LIGHT PIPE & CONNECTOR					
X.XX ±0.15							
X.XXX ±0.10		DRAWN BY	CHECKED BY	APPROVED BY			
Angle ±5°		<i>Janice</i>	<i>Lion</i>	<i>Benson</i>			
		UNIT	SCALE	SIZE	DRAW NO.	REV.	Sheet
10001		MM	NONE	A4	026BM-001	A	5/5