

NOTES:

- 1. 包裝數量 (NUMBER OF CONNECTORS): 1000PCS/REEL
- 2. 引導帶長度 (LEAD TAPE LENGTH)

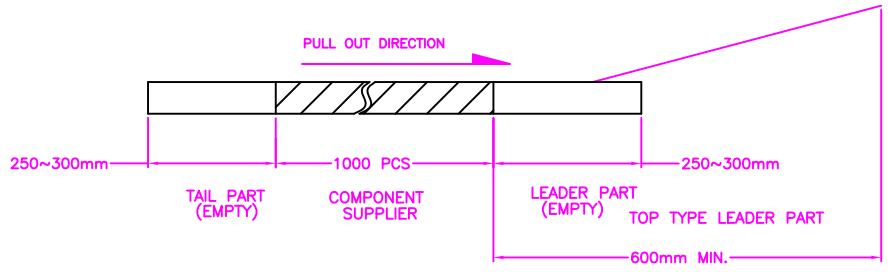

- 3. 上帶剝離強度 (PEELING OFF FORCE OF TOP TAPE) 0.1N~1.3N
- 剝離方向以下圖為參照 (PEELING DIRECTION AS SHOWN IN FOLLOWING FIG)

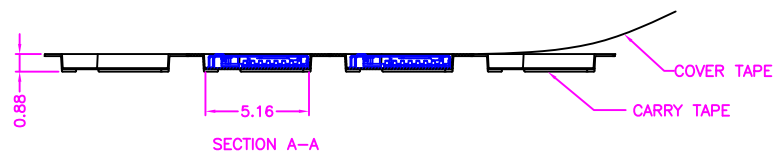
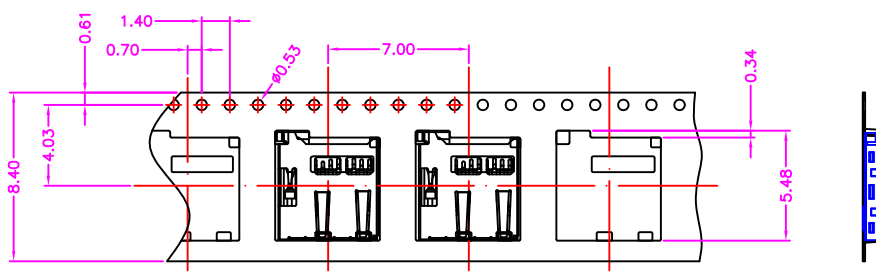
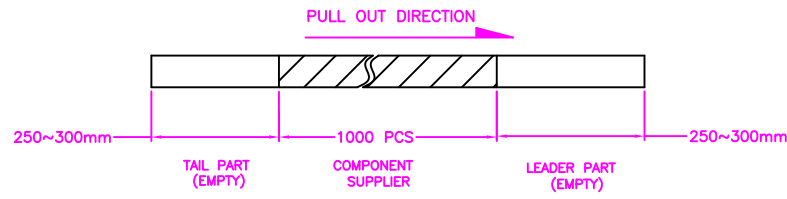
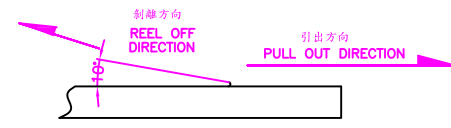

Cyberconn Technology Co., Ltd.
www.cyberconn.com.tw Tel:+886-3-4951314

TOLERANCES X.X ±0.3 X.XX ±0.2 X.XXX ±0.1 Angle ±5°	TITLE	MEMORY CARD SERIES MICRO SD, PCB MOUNT, SMT, METAL SHIELD PUSH-PUSH REVERSE TYPE, FEMALE				
	DRAWN BY	CHECKED BY	APPROVED BY			
	<i>Janice</i>	<i>Lion</i>	<i>Benson</i>			
	UNIT	SCALE	SIZE	DRAW NO.	REV.	Sheet
10023	MM	NONE	A4	4MCKE-001	A	2/3

A	RELEASE	2013.1.11
REV.	DESCRIPTION	DATE

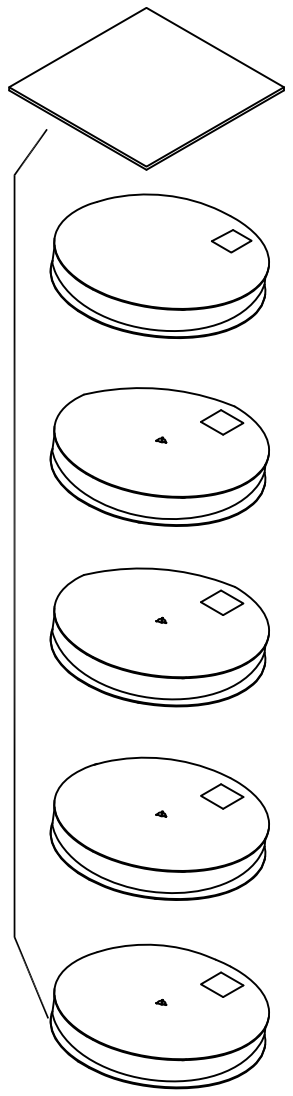

TOTAL LAYERS
6

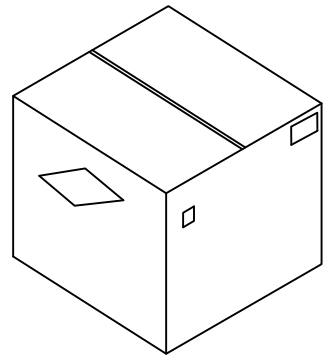
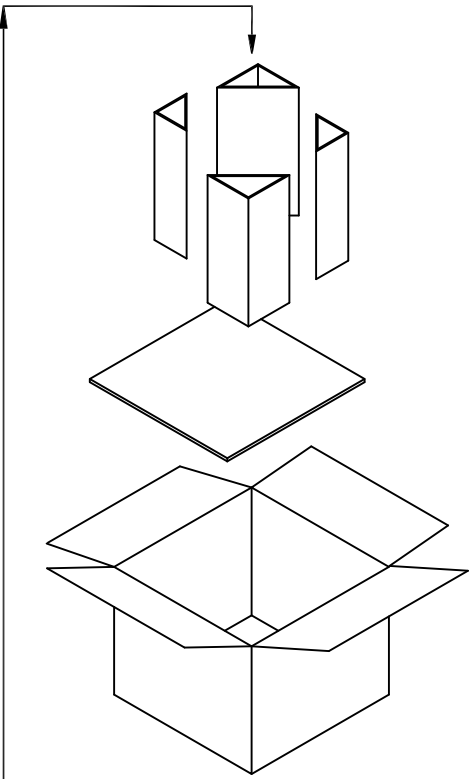

CARTON

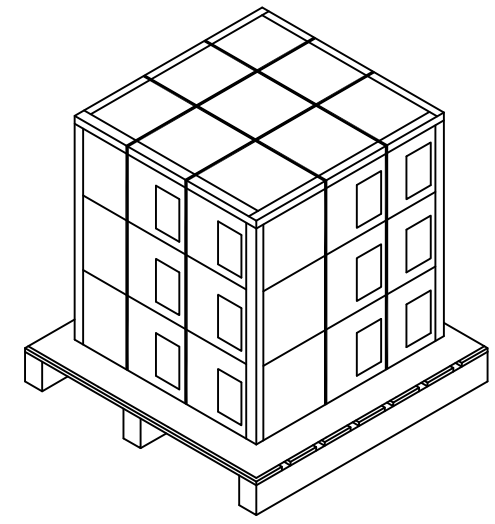

NOTE:
1200pcs/REEL
6000pcs/5REELS/CARTON

A	RELEASE	2013.1.11
REV.	DESCRIPTION	DATE

Cyberconn Technology Co., Ltd. <small>www.cyberconn.com.tw Tel:+886-3-4951314</small>						
TOLERANCES		MEMORY CARD SERIES				
X.X ±0.3		TITLE MICRO SD, PCB MOUNT, SMT, METAL SHIELD				
X.XX ±0.2		PUSH-PUSH REVERSE TYPE, FEMALE				
X.XXX ±0.1		DRAWN BY		CHECKED BY		APPROVED BY
Angle ±5°		<i>Janice</i>		<i>Lion</i>		<i>Benson</i>
	UNIT	SCALE	SIZE	DRAW NO.	REV.	Sheet
	10023	MM	NONE	A4	4MCKE-001	A 3/3