

PART NUMBER:

1HMCA - 5 1 1 * - 1 * 0 * * * *

- SERIES: 1HMCA
 - FIVE ROW: 5
 - NO. OF POS. PER ROW: 1 1
 - CONTACT PLATED OPTION: * - 1 * 0 * * * *
 - PACKAGE OPTION: * * * *
- "H" LENGTH OPTION
 BLANK: WITHOUT SPACE
 1: X=3.10mm
 2: X=9.60mm
- "Y" LENGTH OPTION
 BLANK: WITHOUT SHIELD
 1: X=3.10mm
 2: X=3.70mm
 3: X=13.00mm
 4: X=15.40mm
 5: X=16.00mm
- "X" LENGTH OPTION
 1: X=3.10mm
 2: X=3.70mm
 3: X=13.00mm
- STYLE OPTION
 A: NONE SHIELD
 B: WITH FRONT SHIELD
 C: WITH REAR SHIELD
 D: WITH FRONT & REAR SHIELD
 E: WITH SPACE AND FRONT & REAR SHIELD

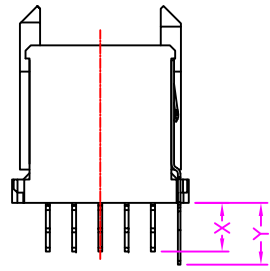
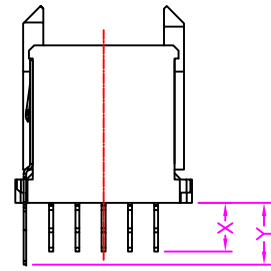
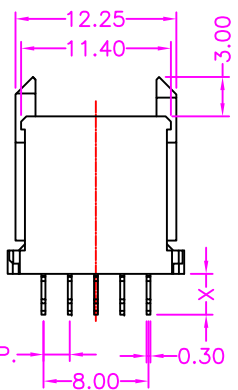
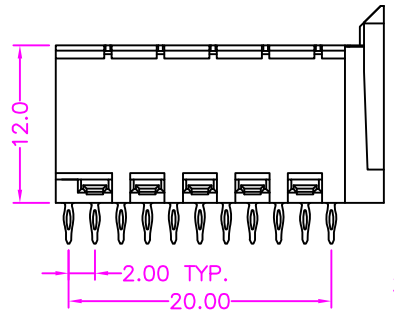
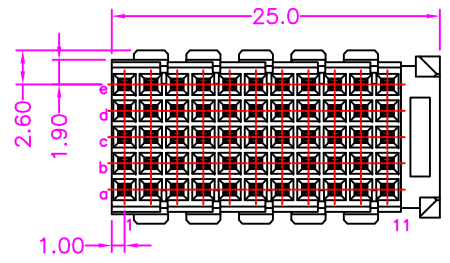

B: WITH FRONT SHIELD

C: WITH REAR SHIELD

A: NONE SHIELD

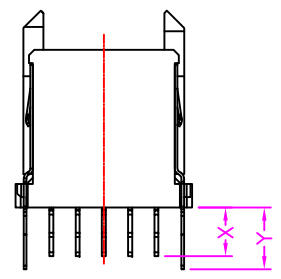
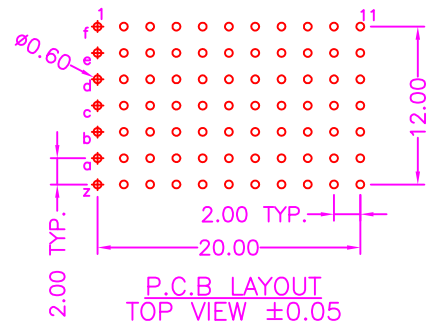

D: WITH FRONT & REAR SHIELD

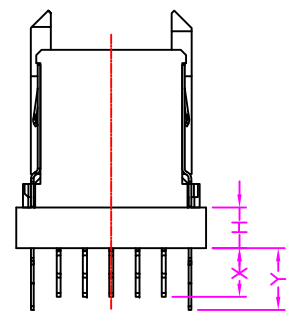

E: WITH SPACE AND FRONT & REAR SHIELD

MATERIALS

HOUSING: THERMOPLASTIC (UL 94V-0)
 TERMINAL: COPPER ALLOY, GOLD PLATED

SPECIFICATION

CURRENT RATING: 1 AMP MAX
 DIELECTRIC WITHSTANDING: 750V AC FOR ONE MINUTE
 CONTACT RESISTANCE: 20m OHMS MAX
 INSULATION RESISTANCE: 1000M OHMS MIN AT DC 500V
 OPERATION TEMPERATURE: -55°C~+125°C

Cyberconn Technology Co., Ltd.
 www.cyberconn.com.tw Tel:+886-3-4951314

TOLERANCES		HARD METRIC CONNECTOR SERIES				
X.X ±0.3		TITLE HARD METRIC, 2.00mm PITCH, PCB MOUNT, VERTICAL, TYPE C, FEMALE				
X.XX ±0.2		DRAWN BY		CHECKED BY		
X.XXX ±0.1		Janice		Lion		
Angle ±5°		APPROVED BY		Benson		
UNIT		SCALE	SIZE	DRAW NO.	REV.	Sheet
10044		MM	NONE	A4	1HMCA-001	A 1/1

A	RELEASE	2011.7.29
REV.	DESCRIPTION	DATE