

MATERIALS
 METAL SHIELD: COPPER ALLOY, NICKEL PLATING
 SPRING: COPPER ALLOY, NICKEL PLATING

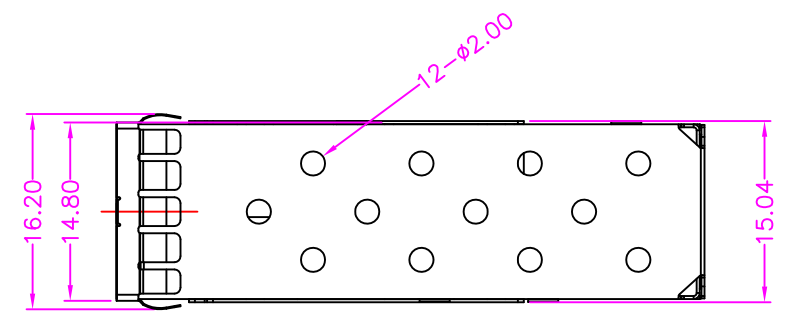

PART NUMBER:
 011AH - 0 N - 1 0
 SERIES TRAY PACKAGE

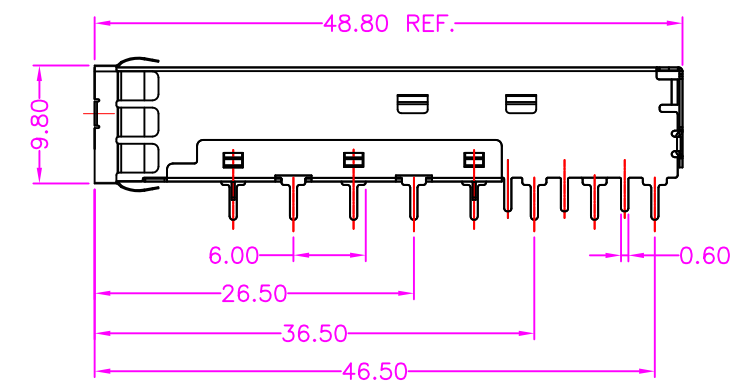
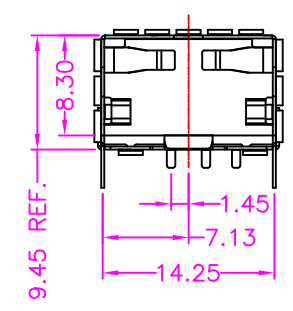

Cyberconn Technology Co., Ltd.
 www.cyberconn.com.tw Tel:+886-3-4951314

TOLERANCES	SFP SERIES					
X.X ±0.3	TITLE SFP PLUS CAGE, R/A, METAL SHIELD, THROUGH HOLE WITH SPRING					
X.XX ±0.2	DRAWN BY		CHECKED BY		APPROVED BY	
X.XXX ±0.1	<i>Janice</i>		<i>Lion</i>		<i>Benson</i>	
Angle ±5°	UNIT	SCALE	SIZE	DRAW NO.	REV.	Sheet
	10001	MM	NONE	A4	011AH-001	A 1/1

A	RELEASE	2011.7.22
REV.	DESCRIPTION	DATE

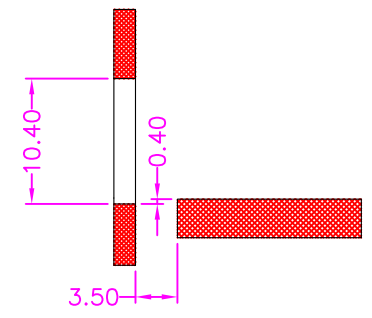
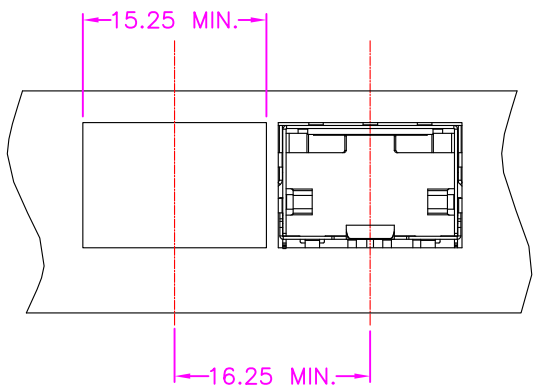

RECOMMENDED PANEL DESIGN

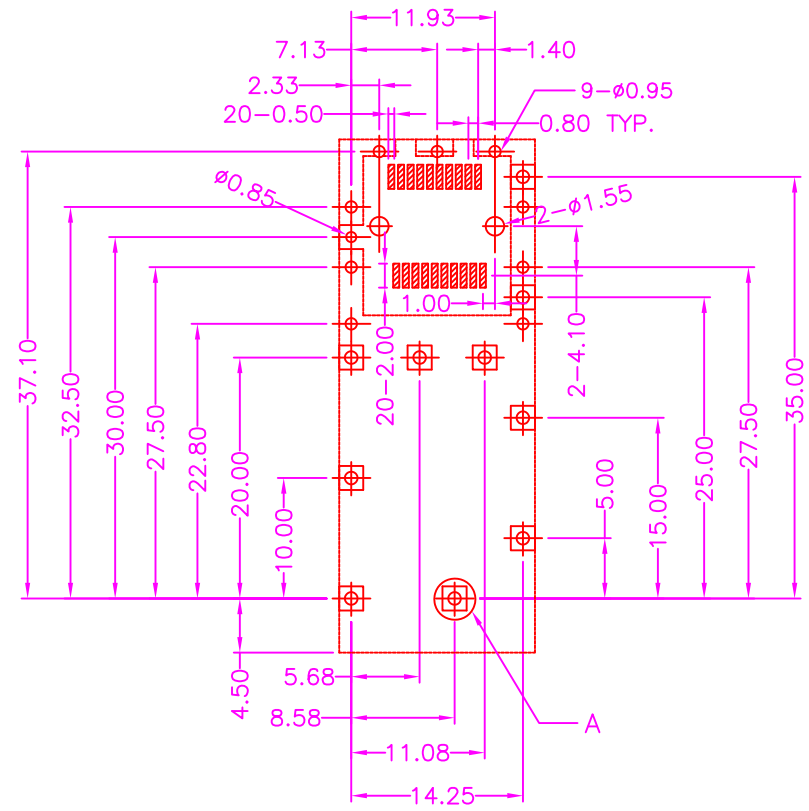

P.C.B LAYOUT
TOP VIEW ±0.05

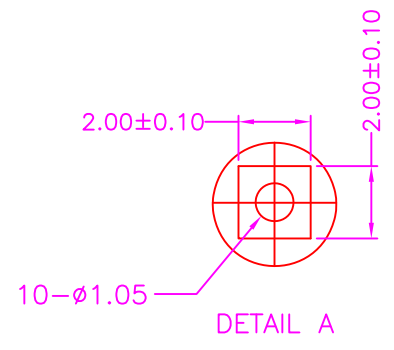

Cyberconn Technology Co., Ltd.
www.cyberconn.com.tw Tel:+886-3-4951314

TOLERANCES	SFP SERIES					
X.X ±0.3	TITLE SFP PLUS CAGE, R/A, METAL SHIELD, THROUGH HOLE WITH SPRING					
X.XX ±0.2	DRAWN BY		CHECKED BY		APPROVED BY	
X.XXX ±0.1	Janice		Lion		Benson	
Angle ±5°	UNIT	SCALE	SIZE	DRAW NO.	REV.	Sheet
	10001	MM	NONE	A4	011AH-001-1	A 1/1

A	RELEASE	2011.7.22
REV.	DESCRIPTION	DATE